

4-120HE



Carriers

10 - 13 ton Excavators

Weight

600kgs

Capacity

0.40m³

Flow

90 lpm

Dimensions

Screening Area

615mm x 1200mm

A - 615mm

D - 1580mm

B - 1200mm

E - 900mm

C - 665mm

F - 890mm

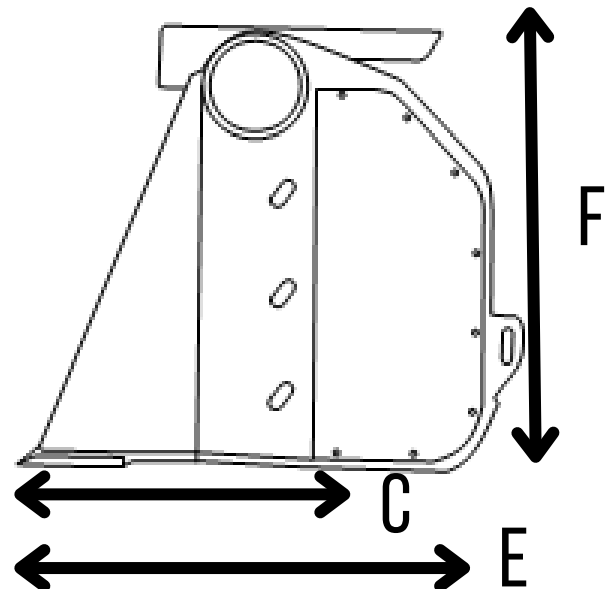
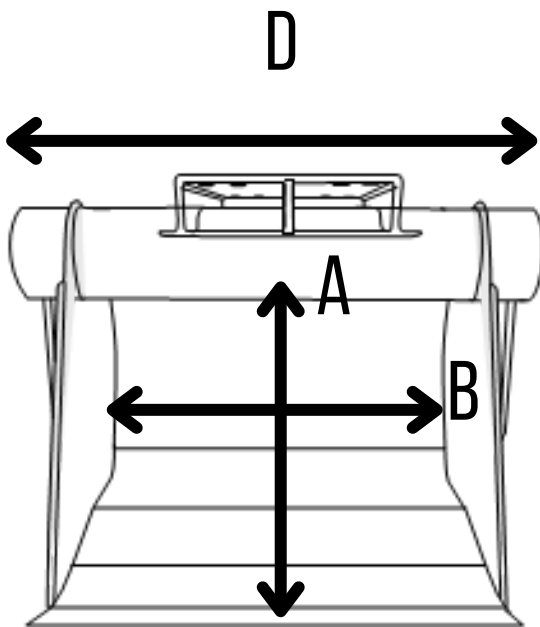

True Compact Screening
Low maintenance System
Poly-Stars screen without crushing
Non-stick floor as standard